

SPEC No.	LH19301B
ISSUE:	Jun.14,2019

To ; _____

S P E C I F I C A T I O N S

Product Name Laser Diode

Model No. GH05230H2K

※These specifications contain 11 pages including the cover and appendix.
If you have any objections, please contact us before issuing purchasing order.

Accepted by:

Sharp Corporation

By: _____

By: T. Kamiyoshi

Name:

Name: Tatsuo Kamiyoshi

Title:

Title: Senior Manager

Date:

Electronic Components and Devices Account Div.

By: _____

Date: Jun. 14, 2019

Name:

Title:

Date:

Sharp Fukuyama Laser Co., Ltd.

By: Y. Hirano

Name: Yasuaki Hirano

Title: Div. General Manager

Development Div. II

Date: Jun. 14, 2019

Reviewed by:

By: A. Ariyoshi

Name: Akira Ariyoshi

Title: Senior Manager

Date: Jun. 14, 2019

Prepared by:

By: M. Ishida

Name: Masaya Ishida

Title: Assistant Manager

Date: Jun. 14, 2019

Product name : Laser Diode

Model No. : GH05230H2K

1. These specification sheets include materials protected under copyright of Sharp Corporation ("Sharp"). Please handle with great cares and do not reproduce or cause anyone to reproduce them without Sharp's consent.
2. When using this Sharp product, please observe the absolute maximum ratings, other conditions and instructions for use described in the specification sheets, as well as the precautions mentioned below.
Sharp assumes no responsibility for any damages resulting from use of the product which does not comply with absolute maximum ratings, other conditions and instructions for use included in the specification sheets, and the precautions mentioned below.

(Precautions)

- (1) In making catalogue or instruction manual based on the specification sheets, please verify the validity of the catalogue or instruction manuals after assembling Sharp products in customer's products at the responsibility of customer.
- (2) This Sharp product is designed for use in the following application areas ;
 - Computers • OA equipment • Telecommunication equipment (Terminal) • Measuring equipment
 - Tooling machines • Audio visual equipment • Home appliancesIf the use of the Sharp product in the above application areas is for equipment listed in paragraphs (3) or (4), please be sure to observe the precautions given in those respective paragraphs.
- (3) Appropriate measures, such as fail-safe design and redundant design considering the safety design of the overall system and equipment, should be taken to ensure reliability and safety when Sharp product is used for equipment in responsibility of customer which demands high reliability and safety in function and precision, such as ;
 - Transportation control and safety equipment (aircraft, train, automobile etc.)
 - Traffic signals • Gas leakage sensor breakers • Rescue and security equipment
 - Other safety equipment
- (4) Sharp product is designed for consumer goods and controlled as consumer goods in production and quality. Please do not use this product for equipment which require extremely high reliability and safety in function and precision, such as ;
 - Space equipment • Telecommunication equipment (for trunk lines)
 - Nuclear power control equipment • Medical equipment
- (5) Please contact and consult with a Sharp sales representative if there are any question regarding interpretation of the above four paragraphs.

3. Disclaimer

The warranty period for Sharp product is one (1) year (or six (6) months in case of generalized product) after shipment. During the period, if there are any products problem, Sharp will repair (if applicable), replace or refund. Except the above, both parties will discuss to cope with the problems.

The failed Sharp product after the above one (1) year (or six (6) month for generalized product) period will be coped with by Sharp, provided that both parties shall discuss and determine on sharing responsibility based on the analysis results thereof subject to the above scope of warranty.

The warranty described herein is only for Sharp product itself which are purchased by or delivered to customer. Damages arising from Sharp product malfunction or failure shall be excepted.

Sharp will not be responsible for the Sharp product due to the malfunction or failures thereof which are caused by:

- (1) storage keep trouble during the inventory in the marketing channel.
- (2) intentional act, negligence or wrong/poor handling.
- (3) equipment which Sharp products are connected to or mounted in.
- (4) disassembling, reforming or changing Sharp products.
- (5) installation problem.
- (6) act of God or other disaster (natural disaster, fire, flood, etc.)
- (7) external factors (abnormal voltage, abnormal electromagnetic wave, fire, etc.)
- (8) special environment (factory, coastal areas, hot spring area, etc.)
- (9) phenomenon which cannot be foreseen based on the practical technologies at the time of shipment.
- (10) the factors not included in the product specification sheet.

4. Please contact and consult with a Sharp sales representative for any questions about Sharp product.

SPEC. No. LH19301B

1. Scope

This specification covers the appearance and characteristics of green Laser Diode,
Model No. GH05230H2K

【Outline of this product】

This product is equipped with an InAlGaN multiple quantum well green laser diode.
Oscillating transverse mode of this model is TE.

- | | |
|--|---|
| 2. Outline Dimensions and Terminal Connections | described in page 2 |
| 3. Ratings and Characteristics | described in page 3 |
| 4. Reliability | described in page 4 |
| 5. Quality level | described in page 5 |
| 6. Supplements | |
| 6-1. ODS materials | described in page 5 |
| 6-2. RoHS compliant product | described in page 5 |
| 6-3. Information relating to China RoHS. | described in page 5 |
| 6-4. Packing | described in page 6 |
| 6-5. Packing | described in page 7 |
| 6-6. Packing | described in page 8 |
| Production place | described on the labels, which are on the clean
or aluminum-bag and on the packing case. |
| 7. Operating and handling precautions | described in page 9 |

3. Ratings and Characteristics

3-1 Absolute Maximum Ratings (Tc=25°C (Note 1))

Parameter	Symbol	Value	Unit
Optical power output (CW)	Po	35	mW
Reverse voltage	Laser diode	Vr1	V
	Photo diode	Vrd	V
Operating temperature (Case temperature)	Top(c)	-10 ~ +60	°C
Storage temperature	Tstg	-40 ~ +85	°C
Soldering temperature (Note 2)	Tsld	350	°C

(Note 1) Tc : Case temperature (Tc measurement point is refer to P3 drawing.)

(Note 2) Soldering temperature means soldering iron tip temperature while soldering.

Soldering position is 1.6mm apart from bottom edge of the case. (Immersion time: ≤3s)

3-2 Electro-optical Characteristics (Tc=25°C (Note 1))

Parameter	Symbol	Conditions	Min.	Typ.	Max.	Unit	
Threshold current	Ith	-	-	25	45	mA	
Operating current	Iop	Po=30mW	-	70	90	mA	
Operating voltage	Vop		-	6.5	7	V	
Wavelength (Note 6)	λp		515	520	530	nm	
Half Intensity Angle(Parallel) (Note 2, 3)	θ //		5	7	9	°	
Half Intensity Angle(Perpendicular) (Note 2, 3)	θ ⊥		19	22	25	°	
Ripple (Note 3, 4)	RI2		-	-	30	%	
Misalignment angle (Parallel) (Note 3)	Δθ //		-3	0	3	°	
Misalignment angle (Perpendicular) (Note 3)	Δθ ⊥		-3	0	3	°	
Differential efficiency	ηd		$\frac{20mW}{I(30mW) - I(10mW)}$	0.45	0.65	-	mW/mA
Kink (Note 5)	K-LI		P1=7mW, P2=21mW P3=35mW	-10	-	10	%
Monitor current	Im	Po=30mW, Vrd=5V	0.05	0.3	0.55	mA	

(Note 1) Initial value, Continuous Wave Operation

(Note 2) Angle of 50% peak intensity (Full angle at half-maximum)

(Note 3) Parallel to the junction plane(X-Z plane)

Perpendicular to the junction plane(Y-Z plane)

(Note 4) RI2=ΔP/P

ΔP: the maximum deviation of the far field pattern from its approximate curve

P: the peak of the approximate curve

- Approximate curve is calculated from the measuring data within the center area at 40% peak value.

- ΔP is calculated on the area within the center area at 25% peak value.

(Note 5) Definition of K-LI

$$K-LI = (P4 - P3) / P3$$

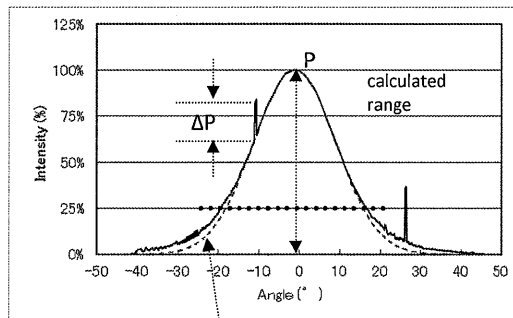

approximate curve (Dotted line)

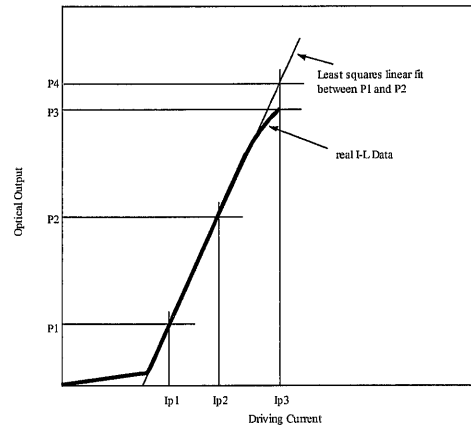

(Note 6) Rank division.

This products are divided by λp value.

λp value is measured by tester which was calibrated by sample which was valued by tester LD4200EBL made by ALPHAX corp..

λp value includes the influence of environment at measurement.

Each rank is described in package label. (see page 6,7)

Rank	Parameter	Conditions	Min.	Typ.	Max.	Unit
①	Wavelength	Po=30mW	515	-	517	nm
②			517	-	519	nm
③			519	-	521	nm
④			521	-	530	nm

4. Reliability

These tests are sampling examples from a specific lot for reference purpose only, and do not constitute any warranty or assurance in connection with the devices.

4-1 Test items and confidence level

Tested samples should have a laser diode chip with the same structure of this model.

These tests are confirmed by performing the operating test under the following conditions in time of development or change process related to the reliability of this product.

Reference Standards : JIS

Confidence level : 90%

No.	Test	Test Conditions	Samples:n	Defective:C	LTPD(%)	Failure criteria No. [4-2]
1	Solderability	Soldering temperature: 240±5°C (Flux used) Immersion time: 5±0.5s	11	0	20	1
2	Resistance to soldering	Soldering iron tip temperature: 350±5°C Immersion time: 3±1s (Note 1)	11	0	20	3, 4, 5
3	Terminal strength (Tensile test)	Load: 5N Duration: 5±1s Once for each terminal	11	0	20	2
4	Terminal strength (Bending test)	Load: 2.5N 0°~90°~0°~ -90°~0° Once for each terminal	11	0	20	2
5	Mechanical shock	Acceleration: 1000m/s ² Pulse width: 6ms Direction: ±X, ±Y and ±Z Three times for each direction	11	0	20	3, 4, 5
6	Variable frequency vibration	Acceleration: 100m/s ² or Amplitude: 1.5mm Frequency: 10~500~10Hz 15min reciprocation Direction: X, Y and Z 2 h for each direction	11	0	20	3, 4, 5
7	Temperature cycling	Lower temperature: -40°C Higher temperature: +85°C Duration: 30min each, 30 times	11	0	20	3, 4, 5
8	High temperature storage	Storage temperature: 85°C t=500 h	11	0	20	3, 4, 5
9	Low temperature storage	Storage temperature: -40°C t=500 h	11	0	20	3, 4, 5

(Note 1) Soldering position is 1.0mm apart from bottom edge of the case.

(Note 2) To be measured after 72 hours exposure to the room atmosphere.

(Note 3) These test results are sampling examples from a specific lot for reference purpose only, and do not constitute any warranty or assurance in connection with the devices.

4-2 Parameters to be measured and Failure criteria

No.	Parameters	Failure judgment criteria
1	Solderability	95% or more is covered with solder.
2	Terminal strength	It is defective if there are breaking and loosening.
3	Threshold current	I _{th} > initial value × 1.3, I _{th} < initial value × 0.7
4	Operating current	I _{op} > initial value × 1.3, I _{op} < initial value × 0.7
5	Operating voltage	V _{op} > initial value × 1.2, V _{op} < initial value × 0.8

4-3 Lifetime Test

The target mean time to failure (MTTF) of this product is more than 2,000 h. MTTF is confirmed by performing the operating test under the following conditions in time of development or change process related to the reliability of this product.

Samples tested should have a laser diode chip with the same structure of this model.

Conditions	Failure judgment criteria
T _c =60°C, P _o =30mW, 500 hours (Note 2)	Failure is defined as the time under the operating current under the conditions in the left changes +50% of the initial (12 h) value. (Note 1) As for the samples which do not fail within 500 hours, their life time is calculated by extrapolating operating current data of between 400 and 500hours. MTTF is estimated by plotting each life time in Weibull function worksheet.

(Note 1) Defective samples caused by surge current is rejected.

(Note 2) APC operation

(Note 3) These test results are sampling examples from a specific lot for reference purpose only, and do not constitute any warranty or assurance in connection with the devices.

SPEC. No. LH19301B

5. Quality level

5-1 Inspection standards ISO 2859 single sampling plan

5-2 Inspection level S-2 normal inspection

5-3 AQL

5-3-1 Definition of the lot the day shipping the product

5-3-2 Characteristics

AQL	Parameter	Failure judgment criteria
1.0	Ith, Iop, Vop, ηd , λp , $\theta //$, $\theta \perp$, R12, $\Delta \theta //$, $\Delta \theta \perp$, K-LI, Im	Not conforming to the specifications

(Note1) Inspection is performed after blowing.

5-3-3 Appearance

AQL	Failure judgement criteria
1.0	Crack is found on the window glass. Marking is not sufficiently clear to read. Bent lead can not be restored. Impurity or dust its size is over $50 \mu m \times 50 \mu m$ is found within $0.4mm \phi$ to the center of the surface of the window glass. (Note 2)
2.5	Diameter of stem is not conforming the specification

(Note 2) Inspection is performed after blowing LD.

6. Supplements

6-1 ODS materials

This product shall not contain the following materials. Also, the following materials shall not be used in the production process for this product.

Materials for ODS : CFCs, Halon, Carbon tetrachloride, 1.1.1-Trichloroethane (Methyl chloroform)

6-2 RoHS compliant product

This product complies with EU RoHS Directive (2011/65/EU) and Commission Delegated Directive (EU)2015/863 and manufactured in accordance with Sharp's Green Device Guidelines.

6-3 Information relating to China RoHS.

Product Information Notification based on Chinese law, Management Methods for Controlling Pollution by Electronic Information Products.

Names and Contents of the Toxic and Hazardous Substances or Elements in the Product

Lead (Pb)	Mercury (Hg)	Cadmium (Cd)	Hexavalent Chromium (Cr (VI))	Polybrominated Biphenyls (PBB)	Polybrominated Diphenyl Ethers (PBDE)
○	○	○	○	○	○

○ : indicates that the content of the toxic and hazardous substance in all the homogeneous materials of the part is below the concentration limit requirement as described in GB/T26572 standard.

× : indicates that the content of the toxic and hazardous substance in at least one homogeneous material of the part exceeds the concentration limit requirement as described in GB/T26572 standard.

SPEC. No. LH19301B

6-4. Packing

Note) This model has 3 way packing type. This packing method is applied to GH05230H2K0E made in Taiwan.

6-4-1. Packing method

- (1) Laser diodes are arranged in a laser tray.
- (2) One tray can accommodate 200 lasers. 5 trays wherein the laser diodes are arranged are stacked up.
- (3) A cover tray is stacked as a cover on the tray wherein the laser diodes are arranged.
Stacked trays including a cover are bound with adhesive tape.
- (4) The above bound trays are stuffed into a clean-bag. The bag is sealed by dissolving thermally.
- (5) The trays in the bag are put into a packing case. One packing case can accommodate 2,000 lasers maximum, which is the minimum unit of packing. A Label where in the model number , quantity and lot number are printed is stuck on both of the bag and the case(Refer to 6-4-4).

6-4-2. Materials for packing

No.	Component parts	Material
1	Laser tray	conductive polystyrene resin
2	Cover tray	conductive polystyrene resin
3	Clean-bag	anti - static plastic
4	Packing case	cardboard
5	shock absorber	anti - static polyetyrene

6-4-3. External appearance of packing

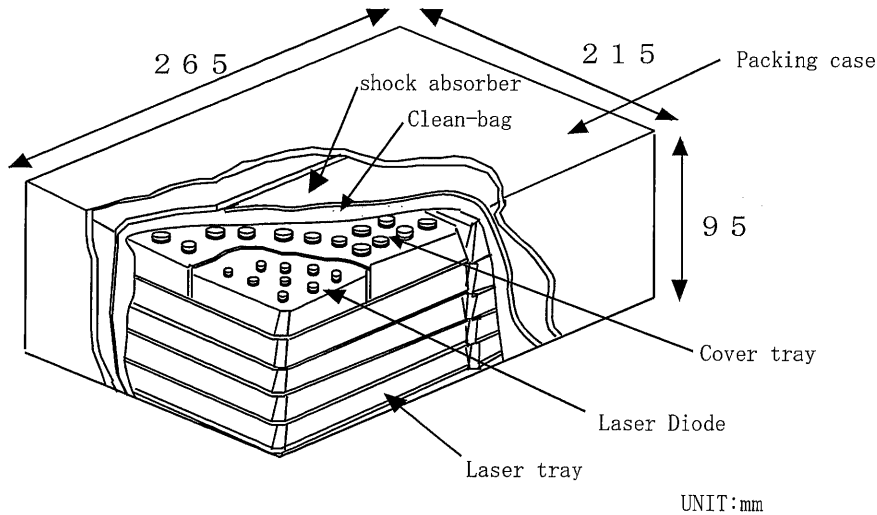

6-4-4. Label

(1) A label on the clean-bag

TYPE	Model name (Note 2)
Q'TY	1000
LOT	Lot No. (Rank)

SHARP CORPORATION
MADE IN ****(Note 1) **R.C.**
(Note 3)

λ p rank is described at this

(2) A label on the packing case

TYPE	Model name (Note 2)
Q'TY	2000
LOT	Lot No. (Rank)

SHARP CORPORATION
MADE IN ****(Note 1) **R.C.**
(Note 3)

λ p rank is described at this

(Note 1) ****:Production country

(Note 2) A management number in the factory is written in (), if the product produced in a factory except Japan.

(Note 3) This identification mark shows the settlement product for RoHS designed by using a green material based on our green device guideline.

SPEC. No. LH19301B

6-5. Packing

Note) This model has 3 way packing type. This packing method is applied to GH05230H2K07 made in Indonesia.

6-5-1. Packing method

- (1) Laser diodes are arranged in a tray.
- (2) One tray can accommodate 400 lasers maximum.
- (3) A vacant tray is stacked as a cover on the tray wherein the laser diodes are arranged. Stacked trays including a cover are bound with adhesive tape.
- (4) The above bound trays are stuffed into a clean-bag. The bag is sealed by dissolving thermally.
- (5) The trays in the bag are put into a packing case. One packing case can accommodate 2,000 lasers maximum, which is the minimum unit of packing. A Label where in the model number , quantity and lot number are printed is stuck on both of the bag and the case(Refer to 6-5-4).

6-5-2. Materials for packing

No.	Component parts	Material
1	Laser tray	conductive polystyrene resin
2	Clean-bag	anti - static plastic
3	Packing case	cardboard
4	shock absorber	anti - static polyetyrene

6-5-3. External appearance of packing

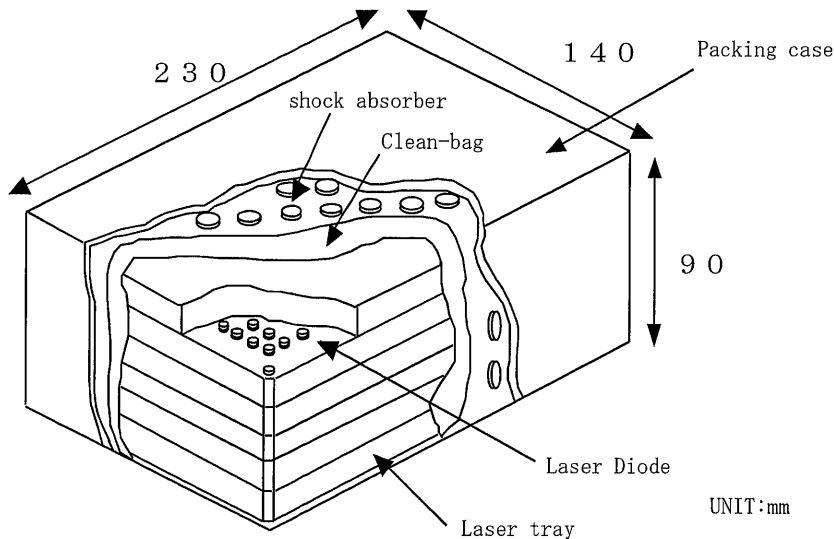

6-5-4. Label

(1) A label on the clean-bag

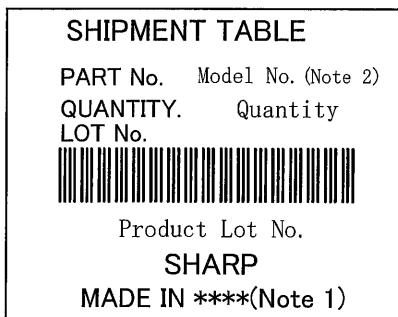

(2) A label on the packing case

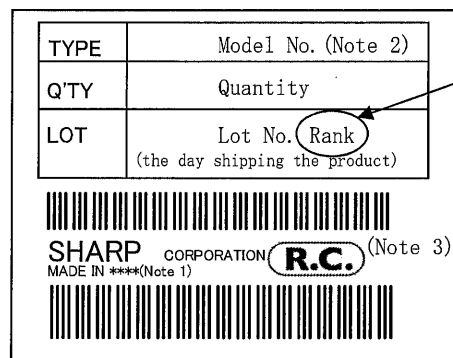

(Note 1) ****:Production country

(Note 2) A management number in the factory is written in (), if the product produced in a factory except Japan.

(Note 3) This identification mark shows the settlement product for RoHS designed by using a green material based on our green device guideline.

6-6. Packing

Note) This model has 3 way packing type. This packing method is applied to GH05230H2K made in Japan.

6-6-1. Packing method

- (1) Laser diodes are arranged in a laser tray.
- (2) One tray can accommodate 250 lasers. 4 trays wherein the laser diodes are arranged are stacked up.
- (3) The empty tray and the tray cover is stacked as a cover on the tray wherein the laser diodes are arranged. Stacked trays including a cover are bound with adhesive tape.
- (4) The above bound trays are stuffed into a aluminum-bag. The bag is sealed by dissolving thermally.
- (5) 2 bags stuffed with trays is accommodated in a packing case. One packing case can accommodate 2,000 lasers maximum, which is the minimum unit of packing. A Label where in the model number, quantity and lot number are printed is stuck on both of the bag and the case(Refer to 6-5-4).

6-6-2. Materials for packing

No.	Component parts	Material
1	Laser tray	conductive polystyrene resin
2	Tray cover	conductive polystyrene resin
3	Aluminum-bag	Aluminum
4	Packing case	cardboard
5	Shock absorber	anti - static polyetyrene

6-6-3. External appearance of packing

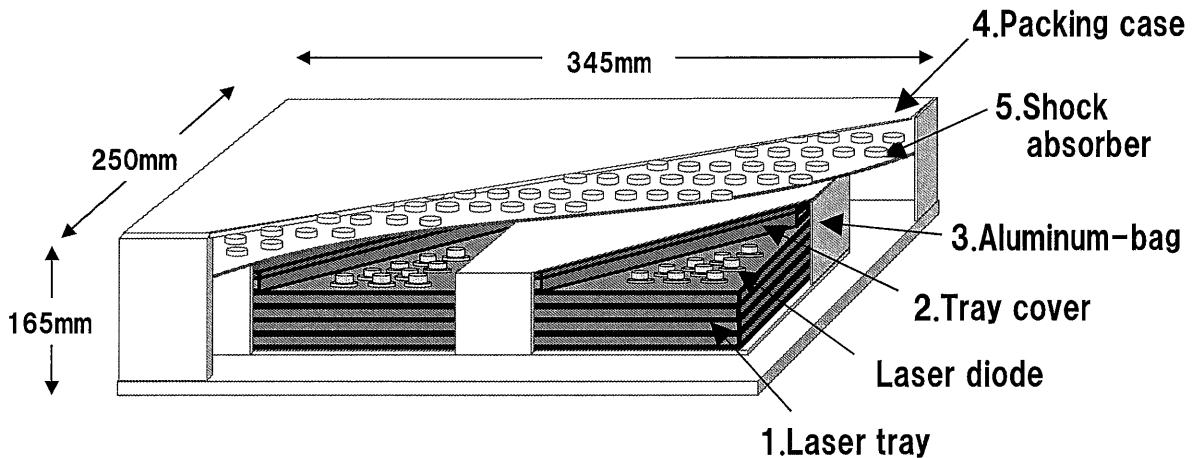

6-6-4. Label

(1) A label on the aluminum-bag

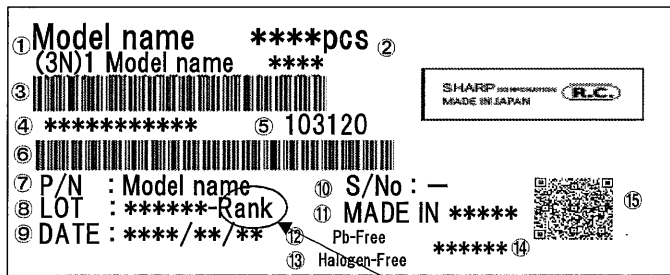

(2) A label on the packing case

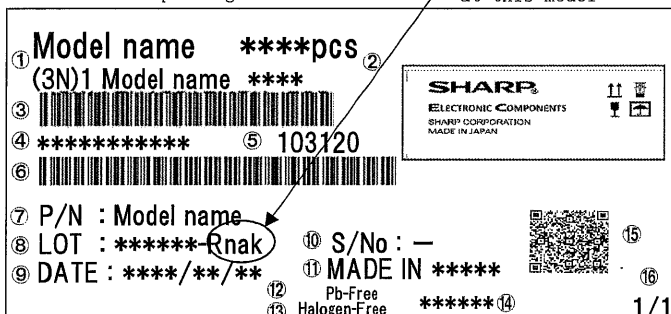

◆Label description

- ① : Model No.
- ② : Quantity
- ③ : 1st bar code:
Customer Name + Quantity
- ④ : Serial No (BOX-ID)
- ⑤ : Company code (Sharp : 103120)
- ⑥ : 2nd bar code :
Serial No + Company code
- ⑦ : Individual model No
- ⑧ : Shipment lot
- ⑨ : Printing date
- ⑩ : Standard
- ⑪ : Country of origin
- ⑫ : Pb-free display
- ⑬ : Halogen-free display
- ⑭ : Label design
- ⑮ : 2-dimensional bar code
- ⑯ : Box fraction

SPEC. No. LH19301B

7. Operating and handling precautions

- (1) This product has its life. The product life which is described in "Reliability" should be taken into account when using it.
- (2) This product will be damaged by electrostatic discharge(ESD). Following precautions should be taken to avoid ESD damage.
 - ⇒ Workers, workbenches and other equipment should always be grounded. Workers should always wear an antistatic wrist strap and an antistatic smock on them.
 - ⇒ When handling this product, workers should always wear antistatic gloves or finger covers.
 - ⇒ A stable DC power supply which is free from electrical transients should always be used when operating this product. A slow starter circuit should always be inserted between the power supply and this product in order to protect it from DC power surges.
 - ⇒ Optical power output of this product should be set with a highly reliable and high quality variable resistance.
 - ⇒ This product should always be connected to the driving circuit by soldering directly or through highly reliable connectors.
 - ⇒ While this product is being operated, be sure to avoid touching the driving circuit or the terminals of this product with electrical probes from a synchroscope or a voltmeter.
 - ⇒ An antistatic package should be used when storing this product.
The recommended preservation is stored in the tray and the clean-bag in an environmental condition dry at normal temperature (0~40°C)
 - ⇒ This product should be processed in the rooms where relative humidity is kept at 50-70%RH.
- (3) This product doesn't do the design that intends use in the following, special environment. Please use it after confirming the performance and reliability, etc. enough in your company before use in the following special environment.
 - ⇒Use in place where a lot of moisture, be dewys, sea breezes, or causticity gases (Cl, H2S, NH3, SO2, and NOX, etc.) exist.
 - ⇒Use under direct sunshine, in out-of-door exposure, or in dust.
 - ⇒Use in atmosphere such as water, oil, drug solutions, or organic solvents.
 - ⇒Use in environment with strong static electricity or electromagnetic radiation.
 - ⇒Use in state installed near generation of heat parts or in state to arrange combustible near this product.
- (4) Because the adhesion of garbage and dust to the window glass might disarrange an optical characteristic of this product, maintain the work room to cleanness so as not generate dust, please.
- (5) In this Product, generation of heat happens in the laser chip because of operating. The case temperature rises by this generation of heat. Because the rise of the case temperature becomes a factor to shorten the lifetime of this product, a sufficient heat sink should be attached to this product when operating so that its case temperature is to be maintained at the same level as that of the surrounding.
- (6) Even if the drive current supply has an automatic power control (APC), automatic current control (ACC), or both, be sure to monitor the optical power output with an optical power meter while setting it. Never estimate the optical power output only from the drive current because it is likely to be decreased by temperature rise of the surrounding.
- (7) When dirt adheres to the window glass of this product, please wipe lightly with the cotton bud that adheres the ethanol.
- (8) This product consists of a hermetic package, in which the green laser diode chip is mounted. The green laser diode chip will be easily damaged by air, moisture or etc. So when the package does not keep hermetically, the lifetime of this product will be remarkably shorten.
Following precautions should be taken to avoid destroying the hermetic package.
 - ⇒The window glass cracks easily because it is thin.
Please do not give an impact to the window glass by dropping this product.
Please avoid applying the stress to the cap, for example clumping, tightening hard, or fixing to the treatment device.
 - ⇒Because applying the overstress to the lead pin or repeating to bend the lead pin at its bottom, will destroy the hermetic seal. Please do not apply the overstress to the base part of lead pin.
 - ⇒When a large stress is applied to the package, please confirm whether the package is kept hermetically before using this product.
- (9) Since laser beam from this product will be harmful to the human eyes, the following precautions should be taken.
 - ⇒ When this product is being operated, the emitting surface of a chip should not be viewed either directly or through a lens, microscope or optical fibers.
 - ⇒ When operating this product, wear safety glasses.
- (10) When soldering this product, heat lead pins only using a soldering iron in short time. Avoid heat the whole package using pre-heat or reflow soldering.